

1 The Eastgate Office Centre
Eastgate Road
Bristol BS5 6XX
United Kingdom



Switchboard: +44 (0)117 951 5151
Main Fax: +44 (0)117 952 4103
E-mail: general@vca.gov.uk
Web Site: www.vca.gov.uk

VEHICLE CERTIFICATION AGENCY

THE UNITED KINGDOM VEHICLE APPROVAL AUTHORITY

Rev 1/03



COMMUNICATION CONCERNING THE APPROVAL GRANTED OF A TYPE
OF DEVICE PURSUANT TO REGULATION NO: 7.02

Approval No: 0496

1. Trade name or mark of the device: PEREI, STIRLING or NOREP
2. Manufacturer's name for the type of device: CRL 12
3. Manufacturer's name and address:

Perei Group Limited
Sunbury House
Christy Estate
Ivy Road
Aldershot
GU12 4TX
United Kingdom
4. If applicable, name and address of the manufacturer's representative: Not applicable
5. Submitted for approval on: 16 February 2004
6. Technical service responsible for conducting approval tests: BSI Product Services
7. Date of report issued by that service: 24 February 2004
8. Number of report issued by that service: 247/4399551

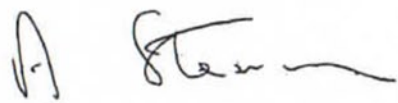

9. Concise description⁽¹⁾:
 By category of lamp: R-SI
 For mounting either outside or inside or both ⁽²⁾ Outside
 Colour of light emitted: Red
 Number and category of filament lamp(s): One P21/5W
 Special supply voltage See BSI test report
 Application of additional supply system yes/no ⁽²⁾ Specification of this supply system
 Switched power supply See BSI test report
 Duty cycle..... peak to peak voltage:....and /or effective voltageVolts
 Geometrical conditions or installation and relating variations if any... See drawing...
 Only for limited mounting height or equal to or less than 750mm above the ground yes/no ⁽²⁾
10. Position of the approval mark: Moulded on lens
11. Reason(s) for extension (if applicable): Not applicable
12. Approval GRANTED
13. Place: BRISTOL
14. Date: 22 MARCH 2004
15. Signature: 
16. The list of documents deposited with the Administrative Service which has granted approval is annexed to this communication and may be obtained on request.



A. W. STENNING
 Head of Product Certification

EAC018070

- ⁽¹⁾ Distinguishing number of the country which has granted/extended/refused/withdrawn approval (see approval provisions in the Regulation)
- ⁽²⁾ Strike out what does not apply
- ⁽³⁾ For lamps with non-replaceable light sources indicate the number and the total wattage of the light sources

1 The Eastgate Office Centre
Eastgate Road
Bristol BS5 6XX
United Kingdom



Switchboard: +44 (0)117 951 5151
Main Fax: +44 (0)117 952 4103
E-mail: general@vca.gov.uk
Web Site: www.vca.gov.uk

VEHICLE CERTIFICATION AGENCY

THE UNITED KINGDOM VEHICLE APPROVAL AUTHORITY

Rev 1/03



COMMUNICATION CONCERNING THE APPROVAL GRANTED OF A TYPE
OF DIRECTION INDICATOR PURSUANT TO REGULATION NO 6.01

Approval No: 0496

1. Trade name or mark of the device: PEREI, STIRLING or NOREP
2. Manufacturer's name for the type of device: CRL 12
3. Manufacturer's name and address:

Perei Group Limited
Sunbury House
Christy Estate
Ivy Road
Aldershot
GU12 4TX
United Kingdom
4. If applicable, name and address of the manufacturer's representative: Not applicable
5. Submitted for approval on: 16 February 2004
6. Technical service responsible for conducting approval tests: BSI Product Services
7. Date of test report issued by that service: 24 February 2004
8. Number of test report issued by that service: 247/4399551



9. Concise description: ^{3/}

Category: 2a,

Number and category of filament lamp(s): One P21W

Geometrical conditions of installation and relating variations, if any: See drawing

Only for limited mounting height of equal to or less than 750 mm above the ground: No

10. Position of the approval mark: Moulded on lens

11. Reason(s) for extension (if applicable): Not applicable

12. Approval GRANTED

13. Place: BRISTOL

14. Date: 22 MARCH 2004

15. Signature:



A. W. STENNING
Head of Product Certification

16. The list of documents deposited with the Administrative Service which has granted approval is annexed to this communication and may be obtained on request.

EAC 018070

^{1/} Distinguishing number of the country which has granted/extended/refused/withdrawn approval (see approval provisions in the Regulation)

^{2/} Strike out what does not apply

^{3/} For lamps with non-replaceable light sources indicate the number and the total wattage of the light sources



CRL12 & 13.



DEPARTMENT OF TRANSPORT
ROOM 805
TOLLGATE HOUSE, HOULTON STREET,
BRISTOL BS2 9DJ

Direct line 0272-218515
Switchboard 0272-218811
Telex 449321



COMMUNICATION CONCERNING THE APPROVAL (OR WITHDRAWAL OF APPROVAL)
OF A TYPE OF DEVICE FOR ILLUMINATING REAR REGISTRATION PLATES
PURSUANT TO REGULATION NO 4

Approval No: 4243

1. Device: Type CRL 13 Grouped rear lights incorporating rear registration plate light
2. trade name or mark: LEP - Alternative Trade Marks: 'RING', 'DURITE', 'ADL', 'DISIMEX'
3. Manufacturer's name: L E Perei Auto Devices Ltd
Sunbury House, Trading Estate
Farnham, Surrey GU9 9NP
4. Name of his representative (if applicable): N/A
5. Address: N/A
6. Type, number and power of lamps: One type P25-2 5 watt
7. Submitted for approval on: 17 February 1987
8. Test Laboratory: British Standards Institution
9. Date of laboratory report: 18 March 1987
10. Number of laboratory report: 130355B
11. Date of approval: 18 March 1987
12. Date of withdrawal of approval: N/A
13. Place: BRISTOL
14. Date: 26 MARCH 1987
15. Signature: *B. V. Woolford* B V WOOLFORD
16. The attached drawing no. 3120 shows geometrically the position in which the illuminating device is to be fitted in relation to the space to be occupied by the registration plate and the outlines of the adequately illuminated area.

4-4346

Sheet No.	No. of Sheets
-----------	---------------

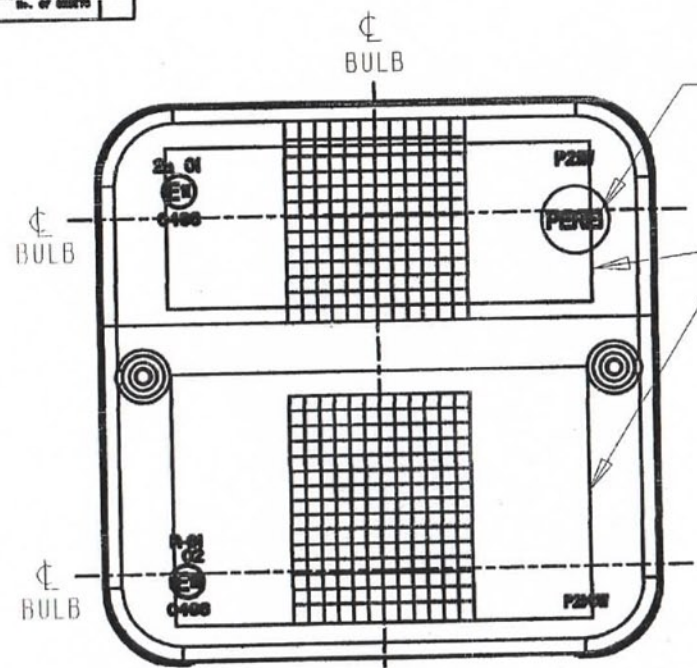

INSERT; ALTERNATE TRADE NAMES: STIRLING, NOREP

SEE NOTE 7

SCALE 1.500

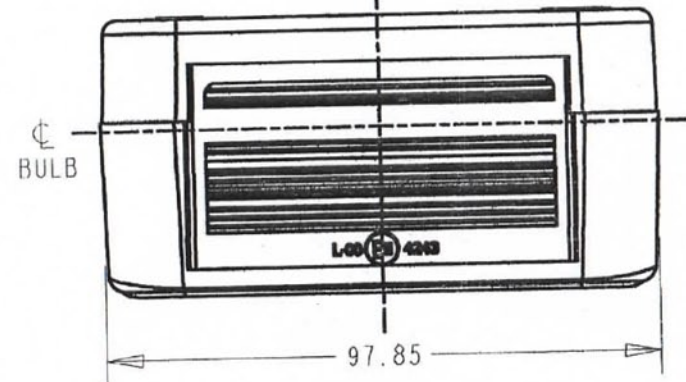
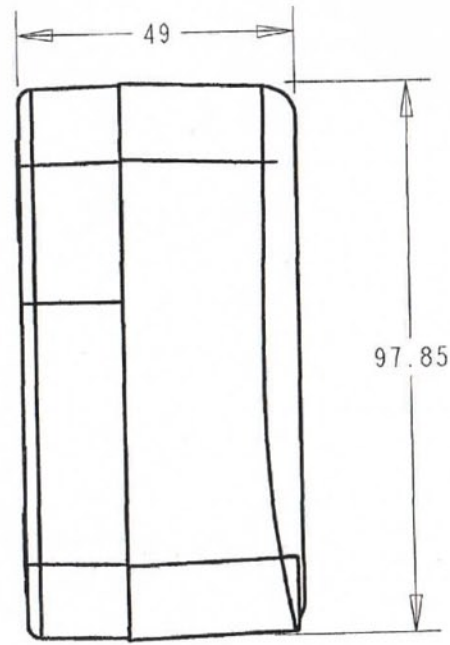
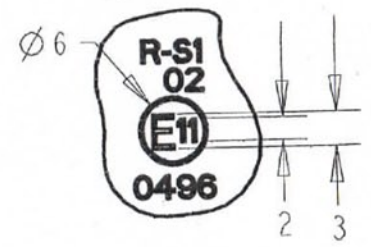

NOTE

- 'CL' OF BULB RELATES TO AXIS OF REFERENCE & CENTRE OF REFERENCE
- MATERIAL:- LENS (AMBER) - PMMA
LENS (RED) - PMMA
NO. PLATE WINDOW (CLEAR) - PMMA
BASE (BLACK) - TALC FILLED POLYPROPELENE
- APPROVALS:-
DIRECTION INDICATOR TO ECE Reg. 6.01
STOP/TAIL TO ECE Reg. 7.02
NO. PLATE TO ECE Reg. 4.00
- BULB TYPE:- STOP/TAIL - P21/5W
DIRECTION INDICATOR - P21W
- LAMP TO BE APPROVED HORIZONTAL/VERTICAL
- SUPERSEDES DRAWING NO. 3119
- APPARENT SURFACE:-
DI - 75mm x 28.3mm (21.22cm squ.)
STOP/TAIL - 73.8mm x 44.9mm (33.13cm squ.)
- SCALE:- 3:4 U.O.S.



PROPERTY OF PEREI GROUP LTD.		
2	REF NO.: 404	29.10.0
Report No 247/4399551 Page 17 of 17		

GENERAL	SEE NOTE	
IDENTITY	SEE NOTE	
PERFORMANCE		
EQUIPMENT IDENTIFICATION		
MARK	DL	10-00-
GROUP	CR	20-10-
APPROVED	ST	20-10-
<small>DESIGNER: PEREI GROUP, QUALITY CONTROL: PEREI GROUP, MANUFACTURER: PEREI GROUP, THIS DRAWING IS THE PROPERTY OF PEREI GROUP AND IS NOT TO BE REPRODUCED WITHOUT THE WRITTEN PERMISSION OF PEREI GROUP.</small>		
<small>NAME OF APPROVING BODY: U.K. APPROVAL AUTHORITY</small>		
TITLE: CRL12 BS1		
DRAWING NO.: 1-131		

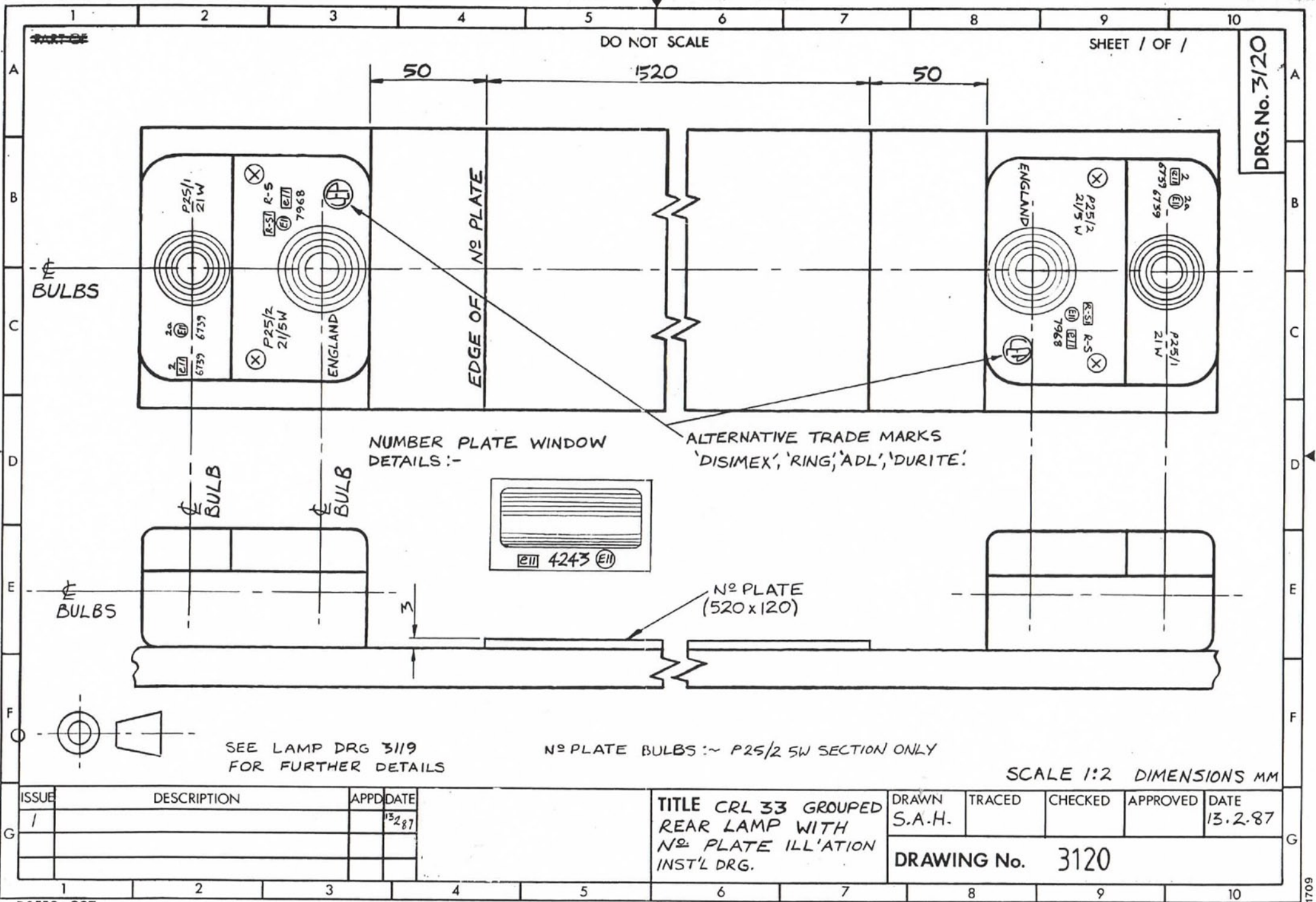

DO NOT SCALE

SHEET / OF /

DRG. No. 3120

NUMBER PLATE WINDOW DETAILS :-

ALTERNATIVE TRADE MARKS 'DISIMEX', 'RING', 'ADL', 'DURITE'

Nº PLATE (520x120)

SEE LAMP DRG 3119 FOR FURTHER DETAILS

Nº PLATE BULBS: ~ P25/2 5W SECTION ONLY

SCALE 1:2 DIMENSIONS MM

ISSUE	DESCRIPTION	APPD	DATE	TITLE	DRAWN	TRACED	CHECKED	APPROVED	DATE
1			13.2.87	CRL 33 GROUPED REAR LAMP WITH Nº PLATE ILL'ATION INST'L DRG.	S.A.H.				13.2.87
					DRAWING No. 3120				